

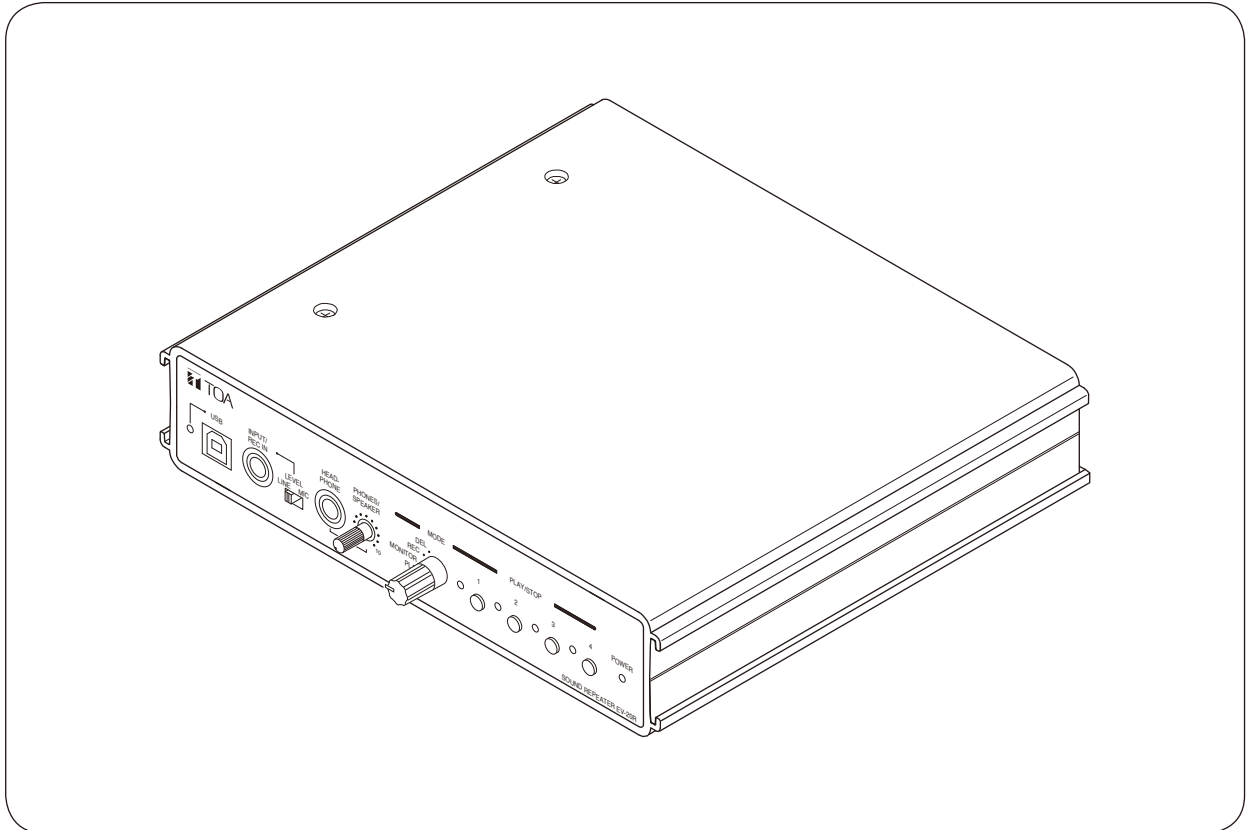

INSTRUCTION MANUAL

SOUND REPEATER

EV-20R



Thank you for purchasing TOA's Sound Repeater.
Please carefully follow the instructions in this manual to ensure long, trouble-free use of your equipment.

TABLE OF CONTENTS

1. SAFETY PRECAUTIONS	3
2. GENERAL DESCRIPTION	4
3. FEATURES	4
4. HANDLING PRECAUTIONS	4
5. PRE-RECORDED AUDIO DATA	4
6. NOMENCLATURE AND FUNCTIONS	5
Front	5
Rear	6
7. OPERATION	7
7.1. Recording (REC)	7
7.2. Confirming the Message (MONITOR)	8
7.3. Playback (PLAY)	8
7.4. Deletion (DEL)	8
7.5. Disabling the Start/Stop Key (LOCK)	8
7.6. Using the Input and Line Input Terminals to Broadcast	9
8. INSTALLATION	10
8.1. Mounting a Single Unit in an Equipment Rack	10
8.2. Mounting Two Units in an Equipment Rack	10
8.3. Installing the Unit on a Desk	10
9. CONNECTIONS	11
9.1. Connection Example	11
9.2. Connections to the Rear-Mounted Connectors	12
10. BROADCAST DELAY TIME AND BUSY OUTPUT ON/OFF SETTINGS	13
11. PLAYBACK INTERVAL SETTINGS	14
12. PLAYBACK OPERATIONS AND CONTROL I/O TIMING	15
12.1. Stopping Broadcasts during Manual Playback or Switching Message Playback	15
12.2. Making Repeat Broadcasts	16
12.3. Playing Back Messages through External Activation	17
13. USING THE SUPPLIED SOFTWARE	18
13.1. System Requirements	18
13.2. CD-ROM File Configuration	18
13.3. Notes on Use of Software	19
14. TROUBLESHOOTING	19
15. SPECIFICATIONS	20
Optional products	20

1. SAFETY PRECAUTIONS

- Before installation or use, be sure to carefully read all the instructions in this section for correct and safe operation.
- Be sure to follow all the precautionary instructions in this section, which contain important warnings and/or cautions regarding safety.
- After reading, keep this manual handy for future reference.

Safety Symbol and Message Conventions

Safety symbols and messages described below are used in this manual to prevent bodily injury and property damage which could result from mishandling. Before operating your product, read this manual first and understand the safety symbols and messages so you are thoroughly aware of the potential safety hazards.



WARNING

Indicates a potentially hazardous situation which, if mishandled, could result in death or serious personal injury.

- Do not expose the unit to rain or an environment where it may be splashed by water or other liquids, as doing so may result in fire or electric shock.
- Use the unit only with the voltage specified on the unit. Using a voltage higher than that which is specified may result in fire or electric shock.
- Do not cut, kink, otherwise damage nor modify the power supply cord. In addition, avoid using the power cord in close proximity to heaters, and never place heavy objects -- including the unit itself -- on the power cord, as doing so may result in fire or electric shock.
- Avoid installing or mounting the unit in unstable locations, such as on a rickety table or a slanted surface. Doing so may result in the unit falling down and causing personal injury and/or property damage.
- Should the following irregularity be found during use, immediately switch off the power, disconnect the power supply plug from the AC outlet and contact your nearest TOA dealer. Make no further attempt to operate the unit in this condition as this may cause fire or electric shock.
 - If you detect smoke or a strange smell coming from the unit.
 - If water or any metallic object gets into the unit
 - If the unit falls, or the unit case breaks
 - If the power supply cord is damaged (exposure of the core, disconnection, etc.)
 - If it is malfunctioning (no tone sounds.)
- Do not place cups, bowls, or other containers of liquid or metallic objects on top of the unit. If they accidentally spill into the unit, this may cause a fire or electric shock.
- Do not touch the power supply plug during thunder and lightning, as this may result in electric shock.



- To prevent possible hearing damage, do not listen at high volume levels for long periods.



CAUTION

Indicates a potentially hazardous situation which, if mishandled, could result in moderate or minor personal injury, and/or property damage.

- Never plug in nor remove the power supply plug with wet hands, as doing so may cause electric shock.
- When unplugging the power supply cord, be sure to grasp the power supply plug; never pull on the cord itself. Operating the unit with a damaged power supply cord may cause a fire or electric shock.
- Avoid installing the unit in humid or dusty locations, in locations exposed to the direct sunlight, near the heaters, or in locations generating sooty smoke or steam as doing otherwise may result in fire or electric shock.
- Make sure that the volume control is set to minimum position before power is switched on. Loud noise produced at high volume when power is switched on can impair hearing.
- Do not operate the unit for an extended period of time with the sound distorting. This is an indication of a malfunction, which in turn can cause heat to generate and result in a fire.
- Use the AC adapter AD-246 (optional) or its equivalent. As for the usable adapter, consult your TOA dealer. Note that the use of an adapter other than specified may cause a fire.
- If dust accumulates on the power supply plug or in the wall AC outlet, a fire may result. Clean it periodically. In addition, insert the plug in the wall outlet securely.
- Switch off the power, and unplug the power supply plug from the AC outlet for safety purposes when cleaning or leaving the unit unused for 10 days or more. Doing otherwise may cause a fire or electric shock.

2. GENERAL DESCRIPTION

The EV-20R Sound Repeater is used to record and play back sounds produced from a microphone, CD player or other sources. Its particularly ideal applications include repeated broadcasts of the same message in schools, department stores and factories. Flash memory is used as a recording medium, and up to 4 different messages can be recorded and played back. The Sound Repeater also permits broadcasts to be made directly from the microphone or CD player without recording.

3. FEATURES

- A USB interface permits audio data to be transferred from a PC.
- Up to 4 messages can be recorded and played back.
- The maximum total recording time for the 4 messages is 6 minutes.
- Recorded data is not compressed, ensuring high quality sound output.
- A built-in power amplifier enables broadcasts with the simple connection of a speaker.
- Analog recording terminals enable direct recording from a microphone or CD player.
- Playback and stop functions can be remotely controlled by way of connected external equipment.
- Repeated broadcasts can be made.

4. HANDLING PRECAUTIONS

- **Warning:** This is a class A products. In a domestic environment this product may cause radio interference in which case the user may be required to take adequate measures.
- **Note:** This equipment has been tested and found to comply with the limits for a Class A digital device, pursuant to Part 15 of the FCC Rules. These limits are designed to provide reasonable protection against harmful interference when the equipment is operated in a commercial environment. This equipment generates, uses, and can radiate radio frequency energy and, if not installed and used in accordance with the instruction manual, may cause harmful interference to radio communications. Operation of this equipment in a residential area is likely to cause harmful interference in which case the user will be required to correct the interference at his own expense.
- To avoid radio interference, keep the unit and the optional AC adapter as far away as possible from radios or wireless tuners.
- Do not open the case nor perform any modifications to the unit, as this may result in unit failure. Leave the inspection, adjustment and repair of the unit's internal circuitry to your TOA dealer.
- The CD-ROM supplied with the unit is not for audio applications, and should not be used in an ordinary audio CD player.
- Internal Copyright Acts prohibit the copy or use of commercially available music and sound data for commercial purposes without the approval of the copyright holder. It is strongly advised that a copyright lawyer be consulted when using such material.
- When cleaning the unit, be sure to switch off the unit's power first, then wipe with a dry cloth. Should the unit become very dirty, use a cloth dampened in a neutral detergent. Never use benzene, thinner or chemically-treated towels, as the unit's finish may be damaged.
- CD-ROM's sample audio data can only be used with the EV-20R, PM-20EV, EV-20A, EV-20S, and S-20S. Never use the data with other products. When wishing to use them with other products than specified, contact your TOA dealer.

5. PRE-RECORDED AUDIO DATA

The following 4 audio sources are pre-recorded in the unit when shipped from the factory.

Message 1	Westminster chime*
Message 2	Ascending 4-tone chime*
Message 3	Descending 4-tone chime*
Message 4	None

* These audio sources are also contained in the supplied CD-ROM as sample audio data.

Note: The above audio sources can be overwritten by using the supplied software.

6. NOMENCLATURE AND FUNCTIONS

[Front]

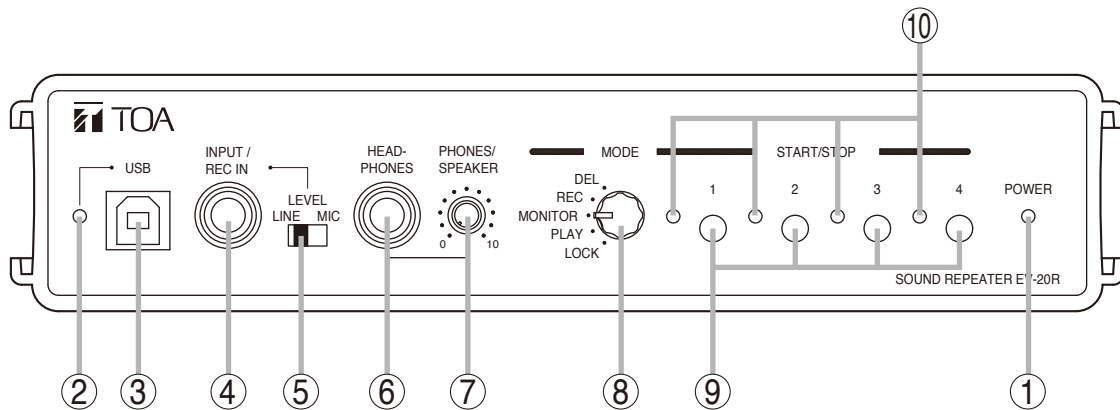

1. Power Indicator [POWER]

Lights when the unit is powered up.

2. USB Communication Indicator

Continuously lights or flashes during USB communications.

3. USB Terminal

Connects to a PC or a USB hub using the supplied USB cable.

4. Input Terminal [INPUT/REC IN]

Connects to a microphone, CD player or other sound source.

MIC signal level: -60 dB, 2.2 k Ω , phone jack, unbalanced

LINE signal level: -20 dB, 10 k Ω , phone jack, unbalanced

5. Input Level Selector Switch [LEVEL]

Set this switch to the MIC position (right side) when connecting a microphone, and to the LINE position (left side) when connecting other sound source equipment.

Factory-preset to the LINE position.

Note: Set this switch to the LINE position when not using a microphone.

6. Headphone Terminal [HEADPHONES]

Connects to a headphone.

0 dB, 100 Ω , phone jack, unbalanced

Note: No signal is provided from the Speaker Output terminal (20) if the headphone is connected.

7. Headphone/Speaker Volume Control [PHONES/SPEAKER]

Adjusts the volume for the Headphone terminal (6) or Speaker Output terminal (20).

8. Mode Selector Switch [MODE]

Selects the operation mode of the EV-20R.

- DEL: Deletes a message.(Refer to p. 8.)
- REC: Records a message.
(Refer to p. 7.)
- MONITOR: Verifies a message.(Refer to p. 8.)
- PLAY: Plays back and broadcasts a message. (Refer to p. 8.)
- LOCK: Disables the Start/Stop key.
(Refer to p. 8.)

9. Start/Stop Key [START/STOP]

Starts and stops the selected message operating in the mode set with the Mode Selector switch (8).

10. Start/Stop Indicator

Continuously lights or flashes according to the operating state.

[Rear]

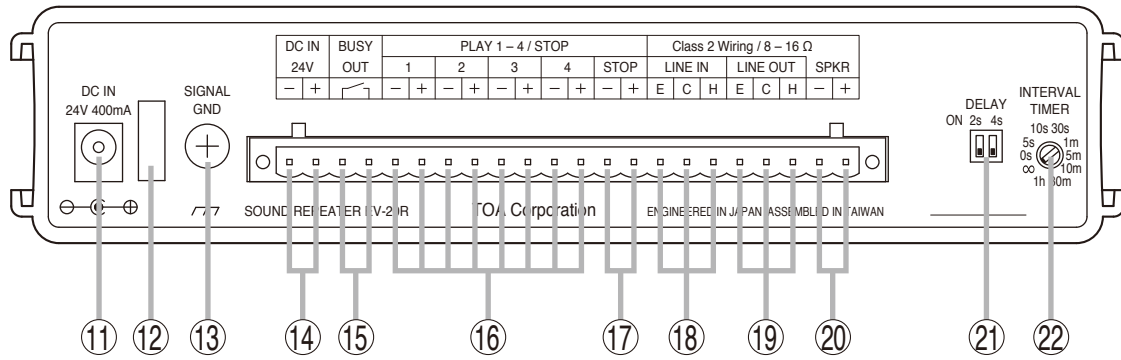

11. AC Adapter Input Terminal [DC IN]

Connects to the optional AD-246 AC adapter or its equivalent.

Tip: When this terminal and the DC Power Input terminal (14) are simultaneously used, the terminal receiving the higher voltage takes precedence.

12. Cord Clamp

Wrap the AC adapter cord around this clamp to prevent the plug from pulling out.

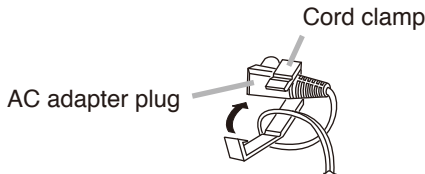

13. Ground Terminal [SIGNAL GND]

Connect this terminal to the ground terminals of the amplifier or other connected equipment.

14. DC Power Input Terminal [DC IN]

Connects to the 24 V DC power supply.

15. Busy Output Terminal [BUSY]

Following message activation, this terminal remains at 'make' until playback is completed. When repeat broadcast mode is selected by the Playback Interval Setting switch (22), the busy output during the set time intervals (except for "0 s" and "∞" settings) can be set to "Make" (ON) or "Break" (OFF) with the Delay Time Setting switch (21). (Refer to p. 13.)
 Contact capacity: 30 V DC, 0.5 A

16. Start Input Terminal [PLAY]

Triggers message playback when closed.
 Contact: No-voltage 'make' contact, triggered by pulse of over 200 ms in length.

17. Stop Input Terminal [STOP]

Stops playback when closed.
 Contact: No-voltage 'make' contact, triggered by pulse of over 200 ms in length.

18. Line Input Terminal [LINE IN]

Connects to external music playback equipment for broadcast. When the EV-20R's message broadcast is started during external equipment broadcast, the message broadcast takes precedence.
 0 dB, 10 kΩ, unbalanced. (Refer to p. 13.)

19. Line Output Terminal [LINE OUT]

Provides output of playback messages or signals input to the Line Input terminal (18).
 0 dB, 600 Ω, unbalanced. (Refer to p. 13.)
 Line Input terminal signals are not output during message playback.

20. Speaker Output Terminal [SPKR]

Connect only low-impedance speakers to this terminal.

21. Delay Time Setting Switch [DELAY]

Sets the delay time between message activation and actual playback start. Also sets the busy output during the time intervals (except for "0 s" and "∞" settings) to "Make" (ON) or "Break" (OFF) when repeat broadcast mode is selected by the Playback Interval Setting switch (22). Setting the busy output to OFF makes the delay time 0 seconds. (Refer to p. 13.)
 The delay time is factory-preset to 0 seconds, and the busy output during intervals between repeated broadcasts to "Make" (ON). (Refer to p. 13.)

22. Playback Interval Setting Switch [INTERVAL TIMER]

Sets playback time intervals between repeated broadcasts of the same message. (Refer to p. 14.)
 This switch is factory-preset to "∞" (Repeat broadcasts disabled).

7. OPERATION

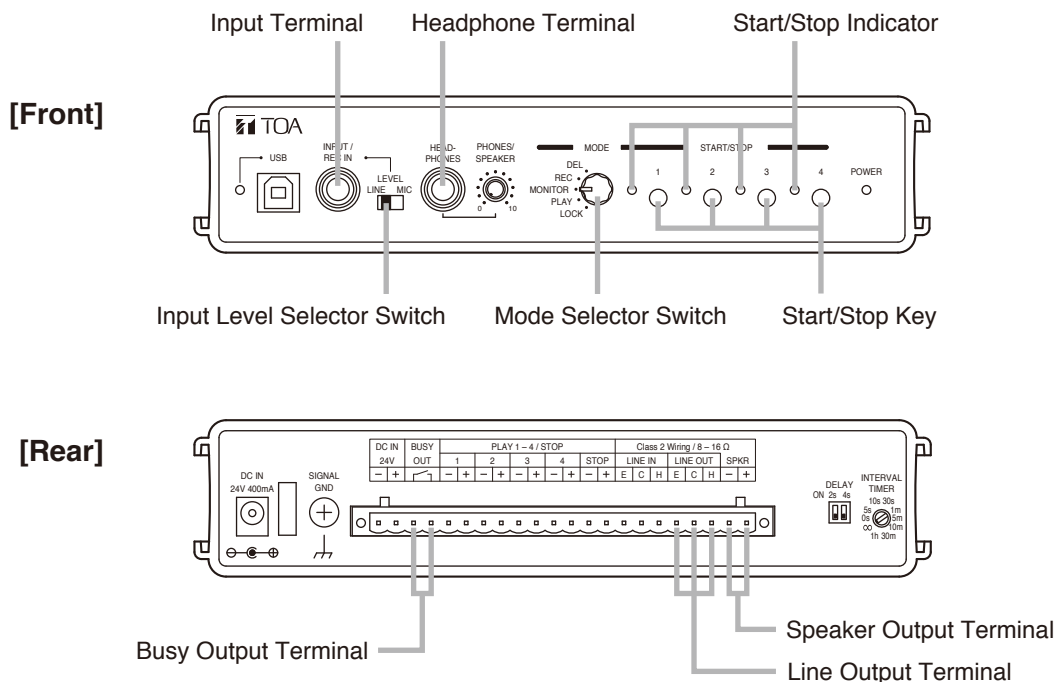

7.1. Recording (REC)

Messages are recorded on the internal flash memory. Up to 4 messages can be recorded, totaling approximately 6 minutes. Because the recording circuitry features automatic gain control (AGC) function, the recording level does not need to be adjusted. When the Mode Selector switch is set to the REC position, the input terminal signal is directed to only the Headphone terminal and Speaker Output terminal, and is not sent to the Line Output terminal.

Note that the input signal to the Speaker Output terminal is cut when headphones are connected.

Step 1. Set the Mode Selector switch to the REC position.

Step 2. Set the Input Level Selector switch to the appropriate position for the type of equipment connected to the Input terminal.
Set to MIC (right side) when a microphone is connected, and to LINE (left side) when other equipment is connected.

Step 3. Connect the microphone, CD player or other equipment to the Input terminal.

Step 4. Press the Start/Stop key for the message number to be recorded, holding it down until the Start/Stop indicator flashes. Recording begins when the indicator mode changes from flashing to steady ON.
(The indicator begins to flash 1 second after the key is pressed. It changes to steady ON 2 seconds after flashing begins.)

Step 5. To stop the recording, press the corresponding Start/Stop key again.

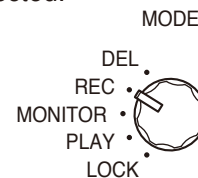

Tips

- The Start/Stop indicator begins flashing when only 5 seconds of recording time remain, and continues until recording is complete.
- Recording over a previously recorded message number automatically deletes the previous recording, without requiring deletion by changing the Mode Selector switch position.
- Recording cannot be performed from the rear-mounted Line Input terminal.
- Sample chime tones contained in the supplied CD-ROM can be transferred to the EV-20R for use. It is also possible to back up the messages using the data transfer software program contained in the supplied CD-ROM. For details, please read the "EV20 Software Instruction Manual.pdf" file located on the CD-ROM.

7.2. Confirming the Message (MONITOR)

The contents of recorded messages can be monitored and confirmed. Messages being monitored can only be heard through the Headphone terminal and the Speaker Output terminal, and are not directed through the Line Output terminal. However, message output from the Speaker Output terminal is disabled if a headphone is connected.

Step 1. Set the Mode Selector switch to the MONITOR position.
The Start/Stop indicators for the recorded message numbers flash.

Step 2. Press the Start/Stop key of the message number to be monitored.
The Start/Stop indicator continuously lights, and monitor playback begins.
The Busy Output terminal is not closed during monitor playback.

Note: Rotating the Mode Selector switch during monitor playback causes the message to stop.

Step 3. To stop monitor playback, press the corresponding Start/Stop key again.

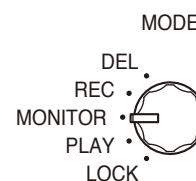

7.3. Playback (PLAY)

Recorded messages can be played back. The message played back is directed through both the Line Output and Speaker Output terminals. However, it is not directed to the Speaker Output terminal if a headphone is connected. In addition, the Busy Output terminal remains at make during playback.

Step 1. Set the Mode Selector switch to the PLAY position.

Step 2. Press the Start/Stop key of the message number to be played back.
The Start/Stop indicator lights and playback begins.
Operation automatically stops and the Start/Stop indicator extinguishes after playback is completed.

Note: The message stops if the Mode Selector switch is rotated during playback.

Step 3. To interrupt the message partway through playback, press the corresponding Start/Stop key again.

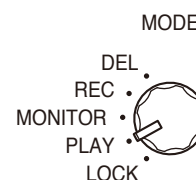

7.4. Deletion (DEL)

To delete a message.

Step 1. Set the Mode Selector switch to the DEL position.
The Start/Stop indicators for the recorded message numbers flash.

Step 2. Hold down the Start/Stop key of the message number to be deleted for 1 second or more.
Only the corresponding Start/Stop indicator stays flashing, while others extinguish.
The Start/Stop indicator extinguishes 3 seconds after the Start/Stop key has been pressed, indicating deletion completion.

[To simultaneously delete all messages]

Hold down Start/Stop keys 1 and 4 for 3 seconds or more. All of the Start/Stop keys light, and deletion begins. In approximately 40 seconds, the indicators will extinguish, indicating all messages have been deleted.

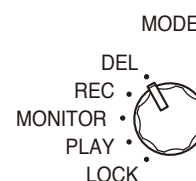

7.5. Disabling the Start/Stop Key (LOCK)

Setting the Mode Selector switch to the LOCK position disables the Start/Stop key. This setting helps prevent malfunctions, especially when operating the unit from only the rear-mounted Start Input terminal.

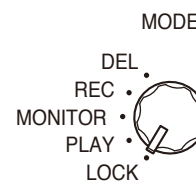

7.6. Using the Input and Line Input Terminals to Broadcast

Voice or audio from the microphone or CD player connected to the Input terminal (INPUT/REC IN) or the Line Input terminal (LINE IN) can also be broadcast, except during the monitor playback of messages 1 – 4 (MONITOR mode) and during playback (PLAY mode). When repeat broadcast mode is selected by the Playback Interval Setting switch, it can be set whether broadcasts from these inputs during the time intervals (except for "0 s" and "∞" settings) are enabled or disabled. (Refer to p. 13.)

Tip

Whether signals from the Input and Line Input terminals are output or not is determined by the setting of the Mode Selector switch and message operating state.

7.6.1. Input terminal [INPUT/REC IN]

Mode	Status	Line Output Terminal [LINE OUT]	Speaker Output Terminal [SPKR]
DEL	Standby	×	✓
	Deletion in progress	×	✓
REC	Standby	×	✓
	Recording in progress	×	✓
MONITOR	Standby	×	✓
	Monitoring in progress	×	×
PLAY or LOCK	Standby	✓	✓
	Playback in progress	×	×

✓ : Broadcast possible from the Input terminal.

×

7.6.2. Line input terminal [LINE IN]

Mode	Status	Line Output Terminal [LINE OUT]	Speaker Output Terminal [SPKR]
DEL	Standby	×	✓
	Deletion in progress	×	×
REC	Standby	×	✓
	Recording in progress	×	×
MONITOR	Standby	×	✓
	Monitoring in progress	×	×
PLAY or LOCK	Standby	✓	✓
	Playback in progress	×	×

✓ : Broadcast possible from the LINE Input terminal.

×

Note

Signals are not directed through the Speaker Output terminal if the headphone is connected.

8. INSTALLATION

8.1. Mounting a Single Unit in an Equipment Rack

Use the optional MB-WT3 Mounting Bracket to mount a single EV-20R unit.

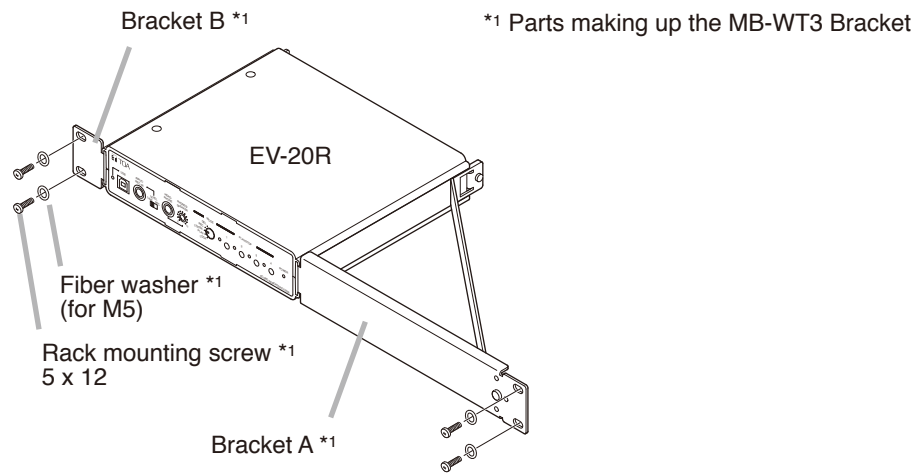

8.2. Mounting Two Units in an Equipment Rack

Use the optional MB-WT4 Mounting Bracket to mount 2 EV-20R units.

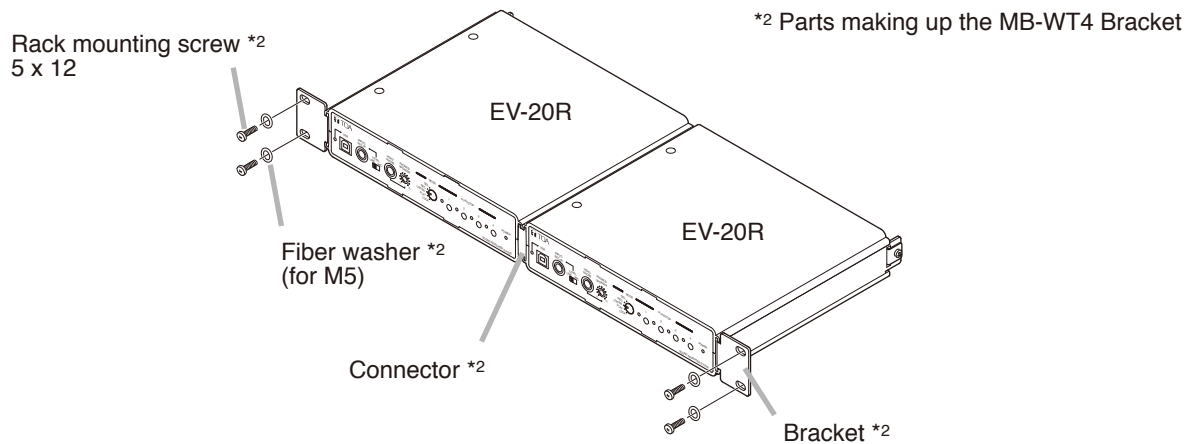

8.3. Installing the Unit on a Desk

Attach the 4 supplied rubber feet to the bottom surface of the unit when installing the unit on the desk.

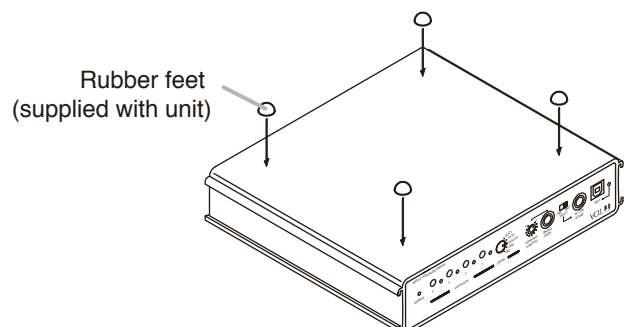

9.2. Connections to the Rear-Mounted Connectors

Notes

- Use the appropriate type of screwdriver for the connector wiring screws.
- When using stranded or shielded cable, do not solder the stripped and exposed ends. When the cable is clamped, the solder becomes crushed, increasing contact resistance and possibly resulting in an extreme rise in cable joint temperature.

9.2.1. Matching cable size

Conductor cross-sectional area	0.5 – 1.5 mm ²
AWG	AWG24 – 16

9.2.2. Stripped cable end

Solid and stranded cables

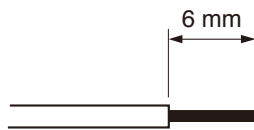

Shielded cable

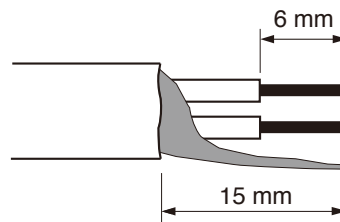

9.2.3. Cable connections

Step 1. Loosen the terminal screw to insert the cable into the connector, then retighten the screw.

Note

Tug lightly on the cable to be sure that it does not pull free. If the cable pulls free, loosen the terminal screw again and reconnect from the beginning.

Step 2. Insert the connector into the rear-mounted socket.

Step 3. Tighten the fixing screw.

Note

Take care not to reverse **Steps 1** and **2**. When tightening the terminal screw, force is applied to the connector pins on the internal circuit board, possibly resulting in poor contact.

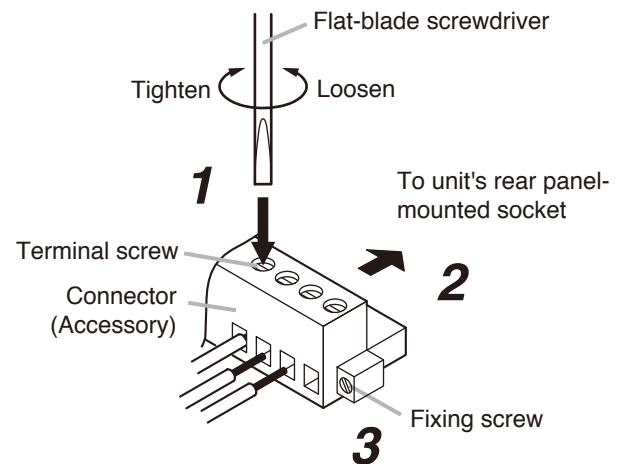

9.2.4. Maximum speaker output cable distance

Refer to the following table for the distance of the cable to be connected to the Speaker Output terminal.

Cable Type (Stranded Cable)	Maximum Distance
0.5 – 1.5 mm ²	20 m

9.2.5. Line input and output terminal connections

Both the Line Input and Output terminals can be converted into balanced types by using optional IT-450 Balanced Transformers. For details, consult with your TOA representative.

[Line Input Terminal]

Unbalanced type (as shipped from factory)

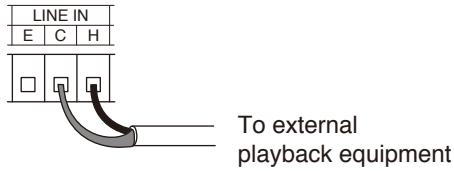

Balanced type (with IT-450)

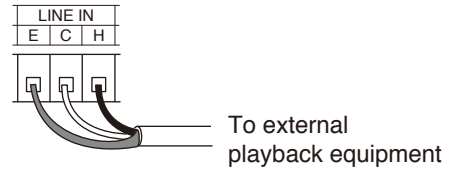

[Line Output Terminal]

Unbalanced type (as shipped from factory)

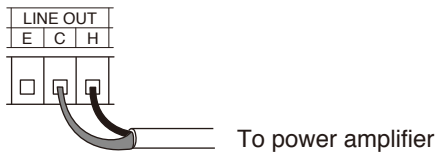

Balanced type (with IT-450)

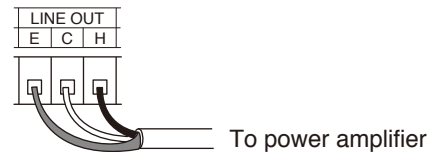

10. BROADCAST DELAY TIME AND BUSY OUTPUT ON/OFF SETTINGS

The delay time between message activation and the actual start of playback can be set to 0, 2, or 4 seconds with the unit's rear-mounted Delay Time Setting switch. When repeat broadcast mode is selected by the Playback Interval Setting switch, the busy output during the time intervals (except for "0 s" and "∞" settings) can be set to "Make" (ON) or "Break" (OFF).

(Factory-preset to "0" seconds, and the busy output during intervals between repeated broadcasts to "ON".)

Should the beginning of playback contents be lost due to operational delays experienced by connected external equipment, set the delay time to 2 or 4 seconds.

Note: If the delay time is set to 2 or 4 seconds, the Busy Output terminal is closed during the delay as well.

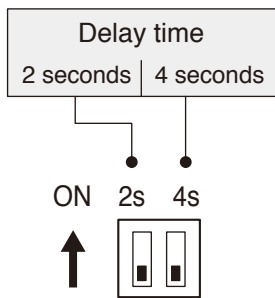

Set Delay Time	Delay Time Setting Switch	Operation during Time Intervals *1	
		Busy Output	Broadcasts using the Input and Line Input Terminals *2
0 seconds (Factory-preset)	ON 2s 4s ↑	ON (Make)	Disabled
2 seconds	ON 2s 4s ↑	ON	Disabled
4 seconds	ON 2s 4s ↑	ON	Disabled
0 seconds	ON 2s 4s ↑	OFF (Break)	Enabled

*1 Valid only when the time intervals (except for "0 s" and "∞" settings) between repeated broadcasts are set by the Playback Interval Setting switch.

*2 Broadcasts using the front-mounted Input terminal (INPUT/REC IN) and rear-mounted Line Input terminal (LINE IN).

11. PLAYBACK INTERVAL SETTINGS

The time interval between repeated message announcements can be set with the Playback Interval Setting switch on the rear panel.

The repeat interval represents the time between the end of the previous message and the start of the next message. Set delay times are not added to the repeat interval.

Set the indentation on the switch axis (marked in black in the figure at right) to the desired timer interval.

Note: The switch is factory-preset to the "∞" position (announcement repetition disabled).

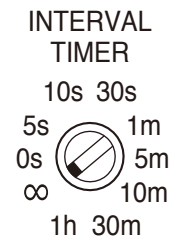

Playback Interval Setting Switch	Setting Contents
∞ (Factory-preset position)	No repeat announcements are broadcast. However, even when "∞" is selected, if the Start Input terminal is continuously closed, the same announcement is continuously broadcast with no interval. Also, opening the input terminal while a broadcast is in progress causes the message to stop immediately after the current playback ends.
0 s	Continuous broadcasts with no pause.
5 s	Broadcasts are repeated after each 5-second pause.
10 s	Broadcasts are repeated after each 10-second pause.
30 s	Broadcasts are repeated after each 30-second pause.
1 m	Broadcasts are repeated after each 1-minute pause.
5 m	Broadcasts are repeated after each 5-minute pause.
10 m	Broadcasts are repeated after each 10-minute pause.
30 m	Broadcasts are repeated after each 30-minute pause.
1 h	Broadcasts are repeated after each 1-hour pause.

Notes

- The Start/Stop indicator flashes until the next message broadcast begins following the end of the previous message broadcast.
- To stop repeat broadcast while in progress, either press the Start/Stop key of the message number being broadcast or close the Stop Input terminal.

12. PLAYBACK OPERATIONS AND CONTROL I/O TIMING

12.1. Stopping Broadcasts during Manual Playback or Switching Message Playback

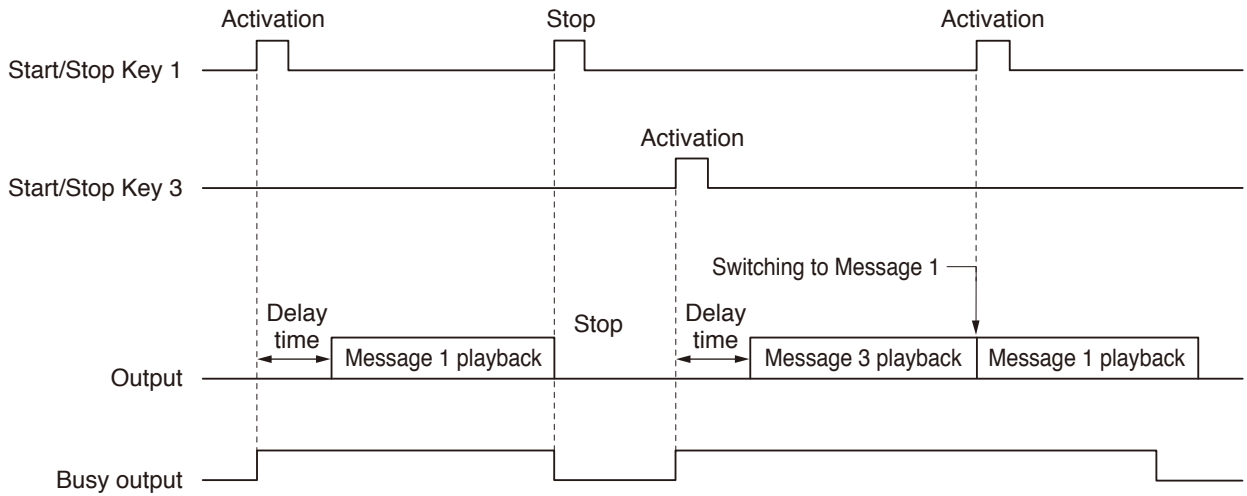

[Operation]

- Pressing the Start/Stop key closes the Busy Output terminal until playback is completed. If the same key is pressed during playback, the playback stops and the Busy Output terminal opens.
- If the Start/Stop key of another message is pressed during playback, playback stops, allowing the most recently activated message to be played back with no delay time.

Note: Current playback can also be made to stop by closing the Stop Input terminal.

12.2. Making Repeat Broadcasts

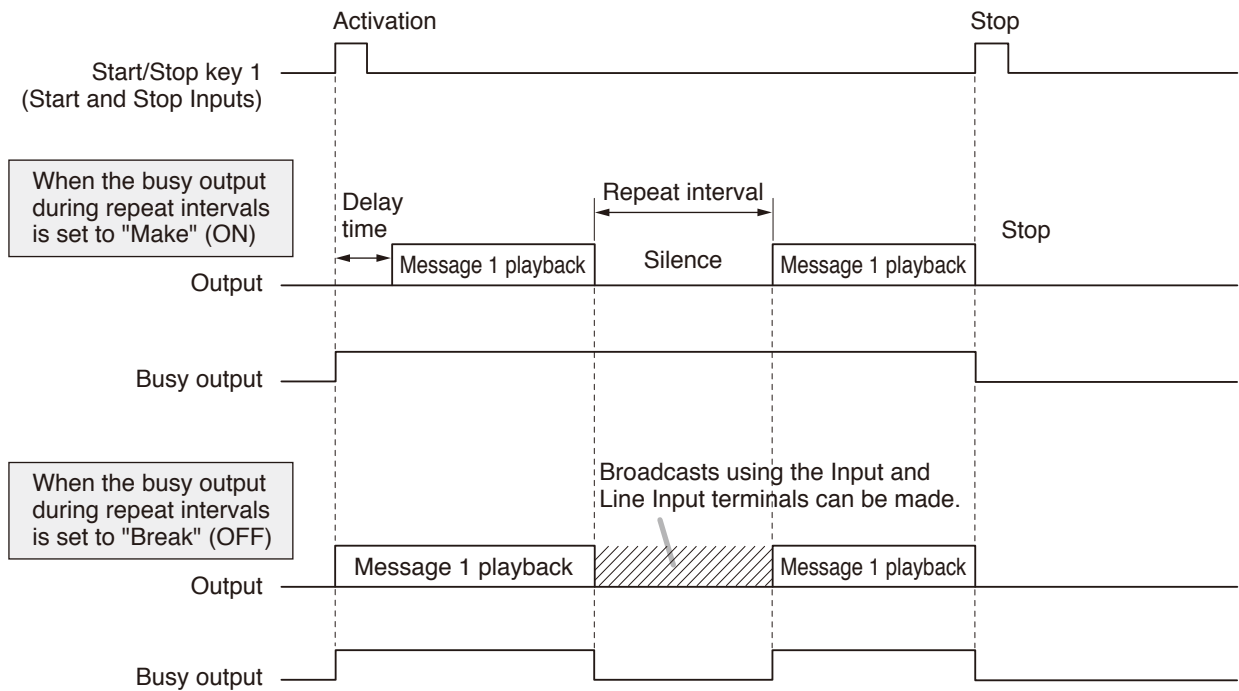

[Operation]

- Pressing the Start/Stop key or closing the Start Input terminal closes the Busy Output terminal and plays back the message after the set delay time elapses.
- When playback ends, the same playback starts again after the time interval between repeat broadcasts elapses. (Refer to p. 14.)
Since then, this operation repeats.
- To interrupt the repeat broadcast, press the in-use message number or close the corresponding Stop Input terminals.
- The busy output during repeat intervals can be set to ON (Make) or OFF (Break) with the Delay Time Setting switch. (Refer to p. 13.)

Depending on the busy output ON/OFF settings, operation differs as follows:

Setting the busy output to ON: No broadcast can be made during the repeat intervals.

Setting the busy output to OFF: Permits broadcasts using the front-mounted Input terminal (INPUT/REC IN) and rear-mounted Line Input terminal (LINE IN) during the repeat intervals.

12.3. Playing Back Messages through External Activation

12.3.1. Message activation

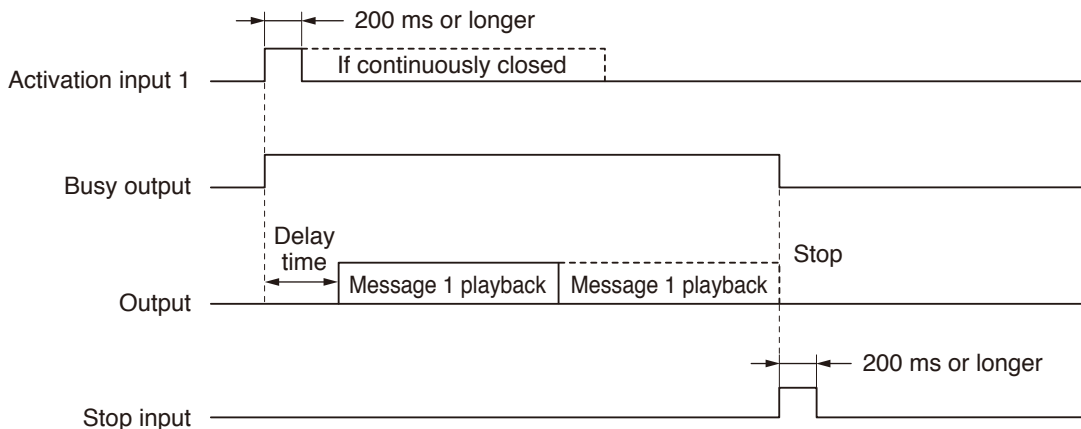

[Operation]

- Closing the Start Input terminal closes the Busy Output terminal and plays back the message after the set delay time elapses. Even if the Start Input terminal opens during playback, the message continues to be played back until it is completed.
- Continuously closing the Start Input terminal causes the same message to be repeatedly played back. Delay time settings are disabled during the repeat playback.
- If the front-mounted Stop key is pressed or the Stop Input terminal is closed during playback, the playback stops, opening the Busy Output terminal as well.
- Closing the Stop input terminal while the Start input terminal is continuously closed stops the playback.

12.3.2. Simultaneous multiple message activation or activation of other message during playback

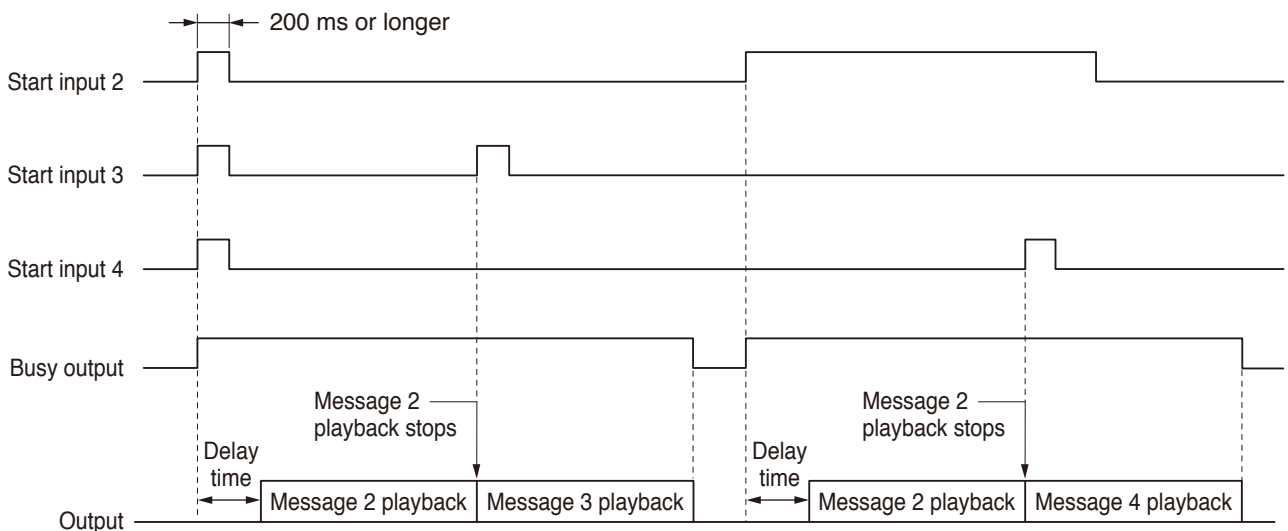

[Operation]

- When two or more Start Input terminals are simultaneously closed, the message with the lower message number is played back, making other messages invalid.
- Closing another Start Input terminal during playback causes the current playback to stop, allowing the message activated later to be played back without the delay time.
- Even if the same Start Input terminal is closed during playback, the playback is not repeated.
- Closing another Start input terminal while a Start input terminal is continuously closed allows the message activated later to be played back.

13. USING THE SUPPLIED SOFTWARE

The EV-20R is equipped with a USB interface jack.

The following operations can be carried out by connecting a PC using the supplied USB cable:

- Uploading the chime tone contained in the supplied CD-ROM.
- Downloading recorded data to the PC. (Recorded data backup)
- Uploading data backed up in the PC.

For instructions regarding installation and use of the supplied software, read the "EV20 Software Instruction Manual.pdf" file located on the CD-ROM.

13.1. System Requirements

Personal Computer	Windows PC (equipped with the USB terminal)
Hardware	CPU: 1 GHz or faster 64-bit (x64) processor Memory: 2 GB or more RAM Free Hard Disk Space: 10 MB or more (space for message storage excluded) Optical Drive: CD-ROM drive
OS	Windows 10 Pro (64-bit edition), Windows 11 Pro (64-bit edition)

Windows is the registered trademark of Microsoft Corporation in the United States and other countries.

13.2. CD-ROM File Configuration

The unit's supplied CD-ROM is configured as follows:

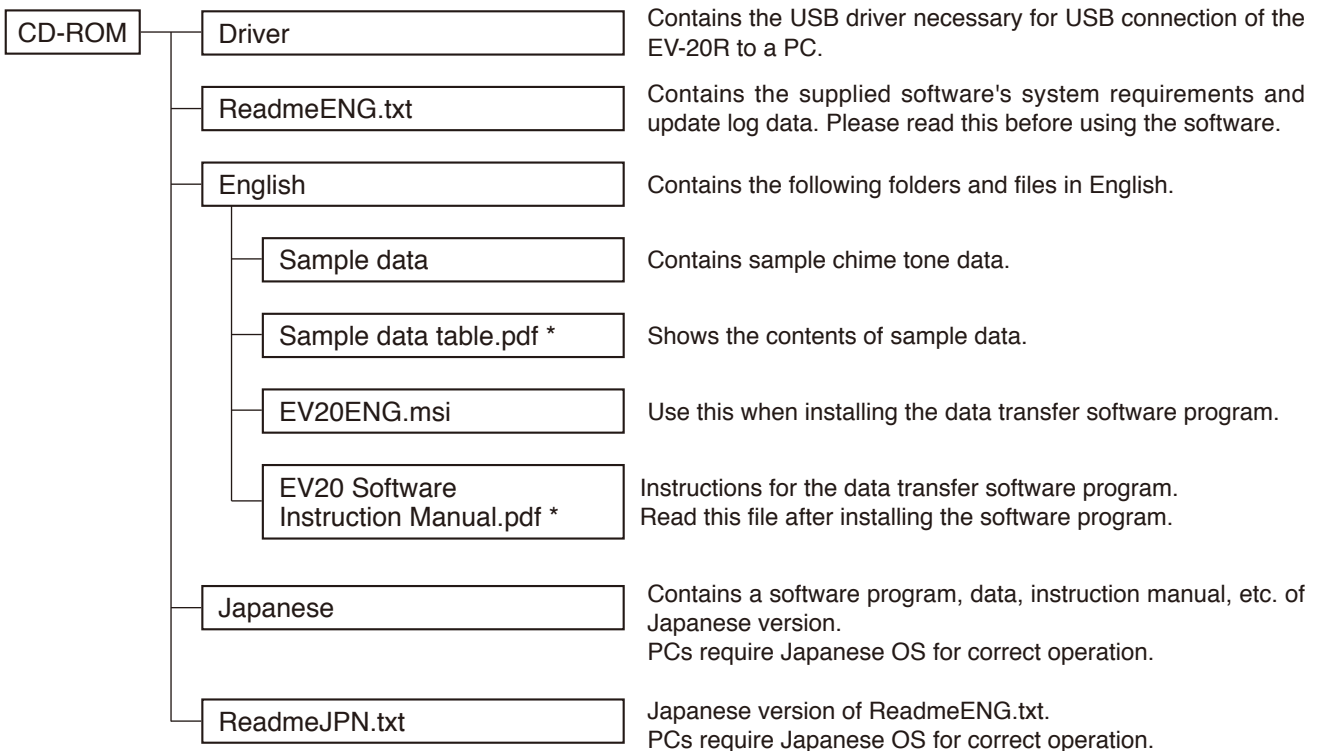

* Acrobat Reader is required to view this file. If Acrobat Reader is not installed in the PC to be used, download it from the Adobe web site.

Note: Both Adobe and Acrobat are trademarks of Adobe Systems Incorporated.

13.3. Notes on Use of Software

- When the EV-20R is in the following operating states, do not switch off its power nor insert or remove the USB cable. PC operation may stop.
 - While the driver software program is being installed.
 - While the OS is being activated or terminated.
 - During the course of being suspended or resumed.
 - While data is being transferred between the unit and the PC.
 - While the sound source is being written or read.
 - While the USB communication indicator is lit.

Because PC operations could also freeze, avoid performing the following:

- Frequent ON and OFF power switching
 - Frequent USB cable insertion and detachment
-
- CD-ROM's sample audio data can only be used with the EV-20R, PM-20EV, EV-20A, EV-20S, and S-20S. Never use the data with other products. When wishing to use them with other products than specified, contact your TOA dealer.

14. TROUBLESHOOTING

Symptom	Cause	Remedy
Cannot record.	Previously recorded messages reached a total of 6 minutes.	Limit total recording time of 4 messages to under 6 minutes.
Recorded sounds distorted.	The Input Level Selector switch is not correctly set during recording.	Set the Input Level Selector switch to MIC position (right side) when the microphone is connected, and to LINE position (left side) when connecting other equipment.

15. SPECIFICATIONS

Power Source	Supplied from an external 24 V DC/400 mA power supply or from an optional AD-246 AC adapter or its equivalent
Power Consumption	10 W (rated output)
Wave Format	4.1 kHz sampling frequency, 16-bit PCM (monaural)
Frequency Response	20 – 20,000 Hz ± 3 dB (1 kHz) 50 – 14,000 Hz ± 3 dB (IT-450 mounted, 1 kHz)
Distortion	Under 1% (1 kHz, rated output)
Recording System	USB data transfer or analog recording
Control Input	Activations 1 – 4, stop: No-voltage make contact input, pulse make length: 200 ms, open voltage: 30 V DC, short-circuit current: 10 mA, terminal block type connector
Control Output	Busy: Contact capacity 30 V DC/0.5 A, terminal block type connector
Input	Input/Recording input: Mic/Line changeable, -60 dB* 12.2 k Ω (MIC), -20 dB* ¹ 10 k Ω (LINE), unbalanced, phone jack Line input: 0 dB* ¹ , 10 k Ω , unbalanced, terminal block type connector
Output	Line output: 0 dB* ¹ , 600 Ω , unbalanced, terminal block type connector Headphone output: 0 dB* ¹ , 100 Ω , unbalanced, phone jack Speaker output: 3 W, 8 Ω , terminal block type connector
LED Indicator	POWER, USB, START/STOP 1 – 4
Maximum No. of Messages	4 Pre-recorded audio data: Message 1 (Westminster chime* ²) Message 2 (Ascending 4-tone chime* ²) Message 3 (Descending 4-tone chime* ²) Message 4 (None) Note: The above audio sources can be overwritten by using the supplied software.
Maximum Recording Time	6 minutes
Message Delay Time	0, 2 s, or 4 s (selectable)
Playback Interval Time	∞ , 0, 5 s, 10 s, 30 s, 1 min, 5 min, 10 min, 30 min, or 1 h (selectable)
Finish	Case: ABS resin, black
Dimensions	210 (w) x 44.2 (h) x 181 (d) mm (excluding projection)
Weight	730 g
Accessories	CD-ROM ... 1, USB cable (1 m) ... 1, Unbalanced phone plug ... 1 Removable terminal plug (22 P) ... 1, Rubber foot ... 4

*1 0 dB = 1 V

*2 Also contained in the supplied CD-ROM as sample audio data.

Note: The design and specifications are subject to change without notice for improvement.

• Optional products

Rack mounting bracket: MB-WT3 (for rack mounting one EV-20R unit)
MB-WT4 (for rack mounting two EV-20R units)
AC adapter: AD-246

Note: Consult your TOA dealer when using an equivalent adapter.

Traceability Information for Europe	TOA Electronics Europe GmbH Suederstrasse 282, 20537 Hamburg, Germany
--	--

<https://www.toa-global.com/en>