

# M-9000

## Digital Matrix Mixer



### DESCRIPTION

The TOA M-9000 Digital Matrix Mixer features a compact design that fits in a two rack space package. The versatile new mixer is ideal for multi-zone paging, music distribution and room-combining applications.

The M-9000 includes eight module ports allowing designers to easily configure custom systems with up to eight mic/line inputs and eight outputs. The M-9000 chassis has two channels of built-in digital signal processing (DSP) with ten band parametric EQ, compressor, eight level ducking and more. Input and output modules provide additional DSP.

Two discrete operation modes, "Mixer" and "Matrix", allow the M-9000 to be used in both simple mixing and complex multi-zone paging applications. Versatile features include telephone zone paging, automatic microphone mixing and ambient noise control.

### SYSTEM FEATURES

- **Modular Digital Matrix Mixer** for a multitude of applications including audio-visual, zone paging, room combining and many more.
- **Dual Modes (Mixer and Matrix)** — two separate feature sets to suit both simple mixing and complex multi-zone distribution applications.
- **Easy to Configure and Operate**
- **Exceptional Audio Quality**
  - 24-bit, 48 kHz sampling
  - Low Distortion - 0.008%
- **Modular System**— up to 8 mic/line inputs and 8 outputs.
- **Dual Channel Digital Signal Processor (DSP):**
  - 10-band parametric EQ
  - High and low pass filters
  - Compressor
  - Loudness contour
  - Bass and treble
  - Delay (Mixer mode)
  - TOA Speaker EQ presets
  - Additional DSP included on D-001T, D-001R and T-001T modules
- **Telephone Zone Paging**— access up to eight zones with optional ZP-001T module
- **Ambient Noise Control**— automatically increase or reduce output levels in response to changes in ambient noise.
- **Multi-function Display** allows programming and operation without a PC.
- **Rack-mount Kit Included (2RU)**

### APPEARANCE AND DIMENSIONAL DIAGRAM

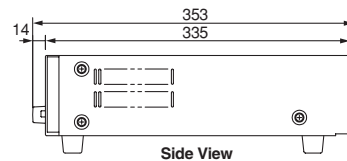
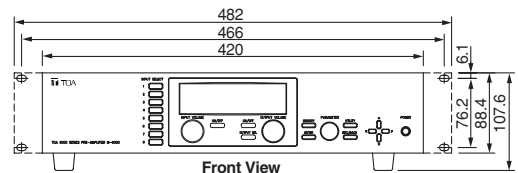
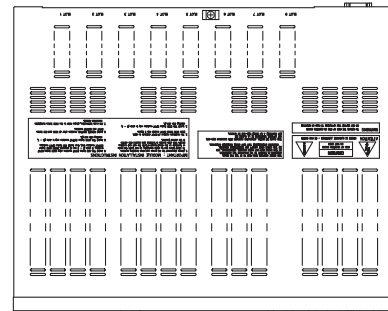
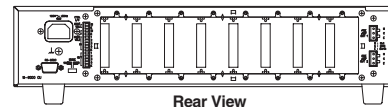

### Flexible Remote Control

#### Two Remote Volume Control Terminals

- Assignable to any input or output channel
- Control with 10k ohm linear potentiometer, 0-10 VDC or optional ZM-9001/ZM-9002 remote panels
- Assign remote volume control to background music (Priority 8) inputs without affecting paging input volume

#### Four Control Inputs (expandable to twelve with C-001T module)—programmable to activate Memory, Volume Up/Down, Mute, Power On/Off, Emergency Mute

- ZM-9003 can also be connected.

#### Four Control Outputs (expandable to twelve with C-001T module) — programmable to activate external relays synchronized with Memory, Channel On/Off and Power On/Off

#### RS-232 Port

- Control protocol available for external devices (see protocol for controllable parameters)
- AMX and Crestron control modules available

### Additional Features

**Software Utility** for saving unit parameters to PC, updating unit firmware, virtual control activation and status indication

**MS Excel Programming Templates** — use Microsoft(R) Excel for off-site programming

**Keylock Security** sets password-protected access to Input, Output, Utility & Power functions

**Input and Output Metering** (D-001 module(s) required for input metering)

**Alphanumeric Channel and Memory Naming**

**Power On Memory** sets the Event/Scene selected when unit powers up

**Detachable AC Cable**



# M-9000 Digital Matrix Mixer

## SPECIFICATIONS

|   |   |
|---|---|
| <b>Power Requirement</b>                    | AC mains, 50/60 Hz  |
| <b>Power Consumption</b>                    | 40W   |
| <b>Audio Input</b>                          | Max. 8 channels, modular construction (modules optional)  |
| <b>Audio Output</b>                         | Preamplifier output 1, 2: 0 dB*, 600 ohms, balanced, removable terminal block (3 pins)  |
| <b>Module Slot</b>                          | Analog input (slot 1 – 8): -10dB*, 10 k ohms, unbalanced<br>Digital input (slot 1 – 4): 24 bit/48kHz<br>MIX output (slot 1 – 8): -14dB*, 330 ohms (CH 1 pre-fader output), unbalanced<br>Digital output (slot 5 – 7): 24 bit/48kHz<br>Power supply (slot 1 – 8): 24V, -24V, -6V DC  |
| <b>Digital Audio Signal Reference Level</b> | -20dBFS   |
| <b>Frequency Response</b>                   | 20 – 20,000 Hz, +1, -3 dB   |
| <b>Total Harmonic Distortion</b>            | 0.008% (at 22 kHz LPF, 1 kHz, +10 dBV output)   |
| <b>S/N Ratio</b>                            | At Input short, 20 – 20,000 Hz, ALL FLAT or OFF setting<br>Output volume min.: 90 dB<br>Output volume max.: 61 dB (input 1 vol.: 0 dB, other inputs: OFF)   |
| <b>Crosstalk</b>                            | Over 64 dB (at 20 kHz)  |
| <b>Tone Control</b>                         | Bass: +/-12 dB (at 100 Hz), Treble: +/-12 dB (at 10 kHz)  |
| <b>Parametric Equalizer</b>                 | 10 bands, Freq: 20 – 20,000Hz, 31 steps, Various range: +/-12 dB, Q: 0.3 – 5  |
| <b>Speaker Equalizer</b>                    | 15 (compatible with TOA speakers only)  |
| <b>High-pass Filter</b>                     | -12 dB/oct, Variable frequency range: 20 – 400 Hz, 14 steps   |
| <b>Low-pass Filter</b>                      | -12 dB/oct, Variable frequency range: 4,000 – 20,000 Hz, 8 steps  |
| <b>Compressor</b>                           | Depth: 1 – 5  |
| <b>Delay</b>                                | 0 – 40 ms (1 ms steps), maximum 40 ms (CH1 + CH2) (Mixer mode only)   |
| <b>Scene/Event Memory</b>                   | 32  |
| <b>Operation Mode</b>                       | Matrix mode/Mixer mode (selector switch)  |
| <b>Auxiliary Function</b>                   | Key lock function   |
| <b>Control Input/Output</b>                 | RS-232C <sup>*2</sup> , D-sub connector (9P, female)<br>Control input: 4 inputs, no-voltage make contact input, open voltage: 3.3 V DC, short-circuit current: under 1 mA, removable terminal block (14 pins)<br>Control output: 4 outputs, open collector output, withstand voltage: 27 V DC, control current: 50 mA, removable terminal block (14 pins)<br>Remote volume: 2 channels, connect a 10 k ohms/linear taper variable resistor or input the DC voltage of 0 to +10V, removable terminal block (14 pins) |
| <b>Operating Temperature</b>                | -10°C to 40°C   |
| <b>Operating Humidity</b>                   | 35% to 80% RH (no condensation)   |
| <b>Finish</b>                               | Panel: Aluminum, hair-line, black, Case: Surface-treated steel plate, black paint   |
| <b>Dimensions</b>                           | 420 (W) x 107.6 (H) x 353 (D) mm  |
| <b>Weight</b>                               | 6 kg (without modules)  |
| <b>Accessory</b>                            | Power cord (2m) x 1, Rack Mounting bracket x 2, Bracket mounting screw x 4, Blank panel x 7, Blank panel mounting screw x 14, Removable terminal plug (3 pins) x 2, Removable terminal plug (14 pins) x 1, CD-ROM x 1, Start guide x 1  |

\* 0dB = 1V

<sup>\*2</sup> Allowing it to be controlled by a control system such as AMX and Crestron through RS-232C port.

Notes: AMX is a trademark of AMX Corporation. Crestron is a trademark of Crestron Electronics, Inc.

# C-001T Control Input/Output Module



## SPECIFICATIONS

|                              |   |
|------------------------------|---|
| <b>Power Requirement</b>     | 6 V DC  |
| <b>Current Consumption</b>   | 15 mA   |
| <b>Control Input</b>         | 8 channels, open voltage: 3.3 V DC, short-circuit current: under 1 mA, removable terminal block (9 pins)                      |
| <b>Control Output</b>        | 8 channels, open collector output, withstand voltage: 27 V DC, control current: max. 50 mA, removable terminal block (9 pins) |
| <b>Operating Temperature</b> | -10°C to +40°C  |
| <b>Finish</b>                | Panel: Aluminum, hair-line  |
| <b>Dimensions</b>            | 35 (W) x 78 (H) x 91.5 (D) mm   |
| <b>Weight</b>                | 62 g  |
| <b>Accessory</b>             | Removable terminal plug (9 pins) x 2, Module mounting screw x 2   |

The C-001T is Control I/O expansion module designed for use with the M-9000 and can provide up to 8 channels each of input and output expansion. Since the main unit has 4 preinstalled inputs and outputs each, the control input and output can be expanded to up to 12 channels each when the C-001T is used.

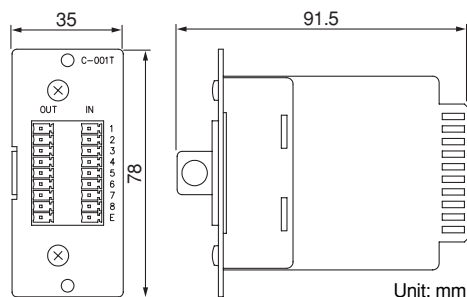

# D-001T Dual Mic/Line Input Module with DSP

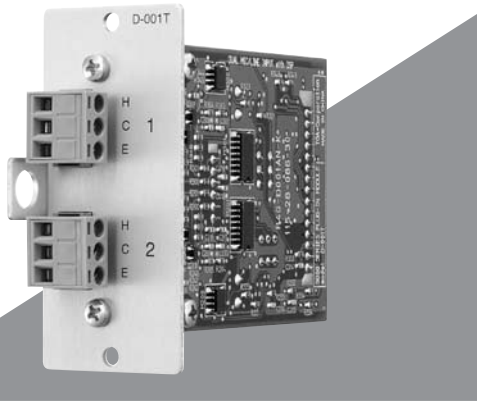

The D-001T is a plug-in module designed for use with the M-9000 and can provide two independent balanced inputs. The D-001T can handle signals ranging from microphone level to line level by controlling their input sensitivity in 9 increments from -60dB to -10dB.

Phantom power (+24V) can be supplied for condenser microphone use. The D-001T can process effect for TONE/EQ/COMPRESSOR to two inputs independently.

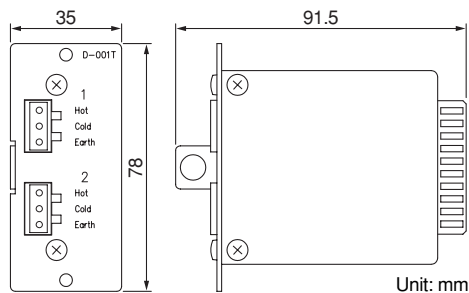

## SPECIFICATIONS

|                               |  |
|-------------------------------|--|
| <b>Power Requirement</b>      | +24 V DC, -24 V DC, +6 V DC  |
| <b>Current Consumption</b>    | 20 mA (at +24 V DC), 20 mA (at -24 V DC), 60 mA (at +6 V DC)   |
| <b>Input</b>                  | 2 channels, 3 k ohms (when the phantom power is ON)/ 10 k ohms (when the phantom power is OFF), electronically-balanced, removable terminal block (3 pins) |
| <b>Input Sensitivity</b>      | -60, -54, -48, -42, -36, -30, -24, -18, -10 dB* (selectable)   |
| <b>Frequency Response</b>     | 20 – 20,000 Hz, +1, -3 dB  |
| <b>THD + N</b>                | 0.008% (at 1 kHz, 20 – 20,000 Hz BPF, Input sensitivity: -10 dB)   |
| <b>Input Equivalent Noise</b> | Under -112 dB (at 20 – 20,000 Hz BPF, Input short, Input sensitivity: -60 dB)  |
| <b>S/N Ratio</b>              | Over 73 dB (at 20 – 20,000 Hz BPF, Input short, Input sensitivity: -10 dB)   |
| <b>Cross Talk</b>             | Over 75 dB (at 20 kHz, Input sensitivity: -10 dB)  |
| <b>CMRR</b>                   | Over 62 dB (at 1 kHz, Input sensitivity: -60 dB)   |
| <b>A/D Converter</b>          | 24 bit $\Delta\Sigma$ ADC  |
| <b>Sampling Frequency</b>     | 48 kHz   |
| <b>Tone Control</b>           | Bass: $\pm 12$ dB (at 100 Hz), Treble: $\pm 12$ dB (at 10 kHz)   |
| <b>Parametric Equalizer</b>   | 10 bands, Frequency: 20 – 20,000 Hz, 31 steps, Variable range: $\pm 12$ dB, Q: 0.3-5   |
| <b>High-pass Filter</b>       | -12 dB/oct, Variable frequency range: 20 – 400 Hz, 14 steps  |
| <b>Low-pass Filter</b>        | -12 dB/oct, Variable frequency range: 4,000 – 20,000 Hz, 8 steps   |
| <b>Compressor</b>             | Depth: 1 – 5   |
| <b>Phantom Power</b>          | +24 V DC   |
| <b>Operating Temperature</b>  | -10°C to +40°C   |
| <b>Finish</b>                 | Panel: Aluminum, hair-line   |
| <b>Dimensions</b>             | 35 (W) $\times$ 78 (H) $\times$ 91.5 (D) mm  |
| <b>Weight</b>                 | 82 g   |
| <b>Accessory</b>              | Removable terminal plug (3 pins) $\times$ 2, Module mounting screw $\times$ 2  |

\*0 dB = 1 V

# D-001R Line Input Module with DSP

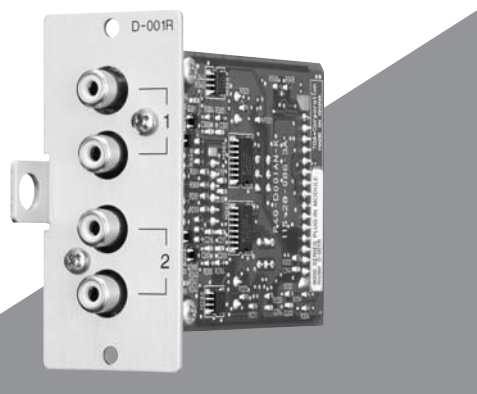

The D-001R is a line input plug-in module designed for use with the M-9000. It has 2-channel unbalanced input of RCA jacks. Input signals to both channels are mixed together. The D-001R can process effect for TONE/EQ/COMPRESSOR to two inputs independently.

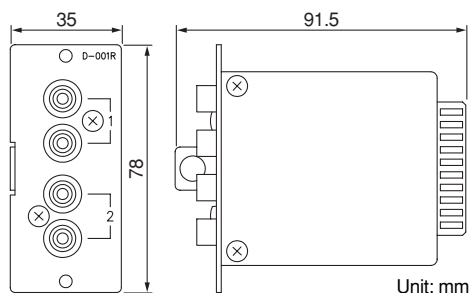

## SPECIFICATIONS

|                              |  |
|------------------------------|--|
| <b>Power Requirement</b>     | +24 V DC, -24 V DC, +6 V DC  |
| <b>Current Consumption</b>   | 20 mA (at +24 V DC), 20 mA (at -24 V DC), 60 mA (at +6 V DC)                           |
| <b>Input</b>                 | 2 channels, 2 RCA/ch mixed, 10 k ohms, unbalanced, RCA pin jack                        |
| <b>Input Sensitivity</b>     | -60, -54, -48, -42, -36, -30, -24, -18, -10 dB* (selectable)                           |
| <b>Frequency Response</b>    | 20 – 20,000 Hz, +1, -3 dB  |
| <b>THD + N</b>               | 0.008% (at 1 kHz, 20 – 20,000 Hz BPF, Input sensitivity: -10 dB)                       |
| <b>S/N Ratio</b>             | Over 70 dB (at 20 – 20,000 Hz BPF, Input short, Input sensitivity: -10 dB)             |
| <b>Cross Talk</b>            | Over 75 dB (at 20 kHz, Input sensitivity: -10 dB)                                      |
| <b>A/D Converter</b>         | 24 bit $\Delta\Sigma$ ADC  |
| <b>Sampling Frequency</b>    | 48 kHz   |
| <b>Tone Control</b>          | Bass: $\pm 12$ dB (at 100 Hz), Treble: $\pm 12$ dB (at 10 kHz)                         |
| <b>Parametric Equalizer</b>  | 10 bands, Frequency: 20 – 20,000 Hz, 31 steps, Variable range: $\pm 12$ dB, Q: 0.3 – 5 |
| <b>High-pass Filter</b>      | -12 dB/oct, Variable frequency range: 20 – 400 Hz, 14 steps                            |
| <b>Low-pass Filter</b>       | -12 dB/oct, Variable frequency range: 4,000 – 20,000 Hz, 8 steps                       |
| <b>Compressor</b>            | Depth: 1 – 5   |
| <b>Operating Temperature</b> | -10°C to +40°C   |
| <b>Finish</b>                | Panel: Aluminum, hair-line   |
| <b>Dimensions</b>            | 35 (W) $\times$ 78 (H) $\times$ 91.5 (D) mm  |
| <b>Weight</b>                | 82 g   |
| <b>Accessory</b>             | Module mounting screw $\times$ 2   |

\*0 dB = 1 V

# T-001T Dual Line Output Module with DSP

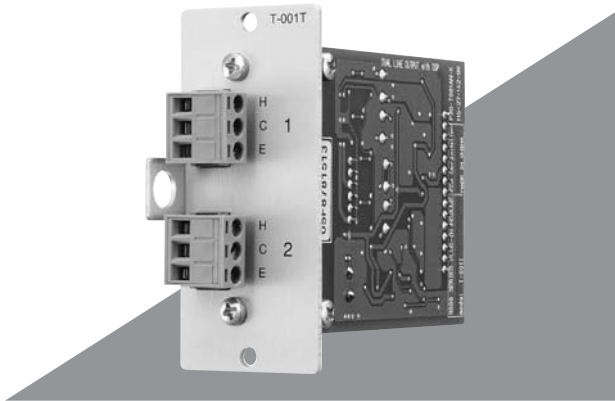

The T-001T is a plug-in module designed for use with the M-9000 and provide two independent balanced outputs. It can drive load of 600 ohms up to +16dB. It can process effect for TONE/EQ/COMPRESSOR to two inputs independently.

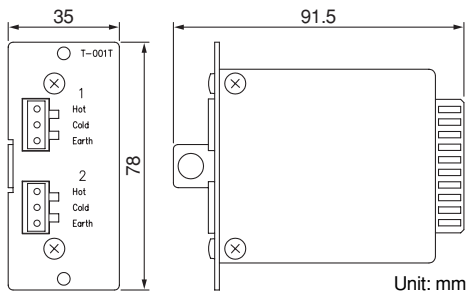

## SPECIFICATIONS

|                              |  |
|------------------------------|--|
| <b>Power Requirement</b>     | +24 V DC, -24 V DC, +6 V DC  |
| <b>Current Consumption</b>   | 35 mA (at +24 V DC), 35 mA (at -24 V DC), 60 mA (at +6 V DC)   |
| <b>Output</b>                | 2 channels, max. +20 dB* (at 10 k ohms load), 600 ohms, electronically-balanced, removable terminal block (3 pins) |
| <b>Frequency Response</b>    | 20 – 20,000 Hz, +1, -3 dB  |
| <b>THD + N</b>               | 0.005% (at 1 kHz, 20 – 20,000 Hz BPF, 5 V output, 10 k ohms load)  |
| <b>S/N Ratio</b>             | Over 73 dB (at 20 – 20,000 Hz BPF)   |
| <b>Residual Noise</b>        | Under -91 dB (at 20 – 20,000 Hz BPF, VOL: -70 dB)  |
| <b>Cross Talk</b>            | Over 87 dB (at 20 kHz)   |
| <b>D/A Converter</b>         | 24 bit $\Delta\Sigma$ ADC  |
| <b>Sampling Frequency</b>    | 48 kHz   |
| <b>Tone Control</b>          | Bass: $\pm 12$ dB (at 100 Hz), Treble: $\pm 12$ dB (at 10 kHz)   |
| <b>Parametric Equalizer</b>  | 10 bands, Frequency: 20-20,000 Hz, 31 steps, Variable range: $\pm 12$ dB, Q: 0.3-5                                 |
| <b>Speaker Equalizer</b>     | 15 (compatible with TOA speakers only)   |
| <b>High-pass Filter</b>      | -12 dB/oct, Variable frequency range: 20 – 400 Hz, 14 steps  |
| <b>Low-pass Filter</b>       | -12 dB/oct, Variable frequency range: 4,000 – 20,000 Hz, 8 steps   |
| <b>Compressor</b>            | Depth: 1-5   |
| <b>Delay</b>                 | 0-40 ms (1 ms step), maximum 40 ms (CH 1 + CH2), mixer mode only   |
| <b>Operating Temperature</b> | -10°C to +40°C   |
| <b>Finish</b>                | Panel: Aluminum, hair-line   |
| <b>Dimensions</b>            | 35 (W) $\times$ 78 (H) $\times$ 91.5 (D) mm  |
| <b>Weight</b>                | 82 g   |
| <b>Accessory</b>             | Removable terminal plug (3 pins) $\times$ 2, Module mounting screw $\times$ 2                                      |

\*0 dB = 1 V

# SS-9001 Speaker Selector

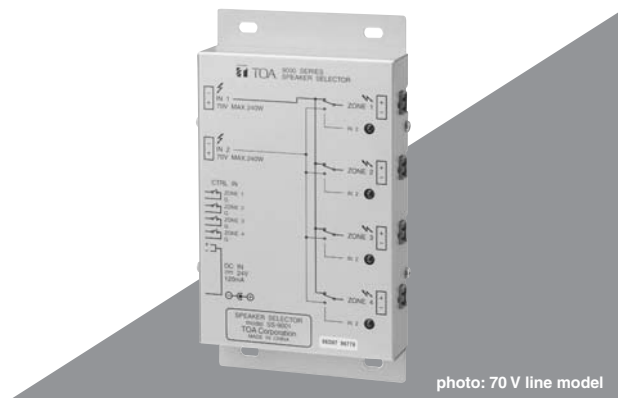

The SS-9001 is a speaker selector used in conjunction with the M-9000. It outputs 2 input signals to 4 different zones.

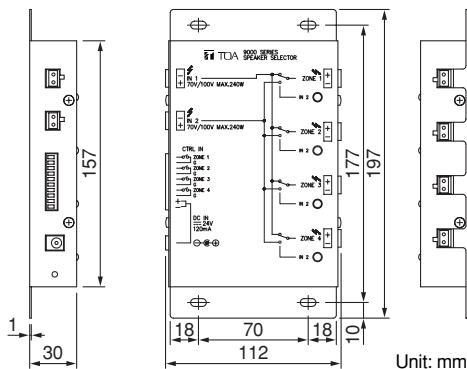

## SPECIFICATIONS

|                              |   |
|------------------------------|---|
| <b>Power Requirement</b>     | Supplied from the optional AD-246 AC adapter or an external 24 V DC/200 mA power supply.  |
| <b>Current Consumption</b>   | 120 mA  |
| <b>Control Signal</b>        | No-voltage make contact input (polarized), open voltage: 24 V DC, short-circuit current: 3 mA   |
| <b>Control Power</b>         | 240 W or less (70 V/100 V line)   |
| <b>Speaker Terminal</b>      | Removable terminal block (2 pins)   |
| <b>Control Terminal</b>      | Removable terminal block (10 pins)  |
| <b>Operating Temperature</b> | -10°C to +40°C  |
| <b>Finish</b>                | Case: Surface-treated steel plate   |
| <b>Dimensions</b>            | 112 (W) $\times$ 197 (H) $\times$ 30 (D) mm   |
| <b>Weight</b>                | 530 g   |
| <b>Accessory</b>             | Removable terminal plug (2 pins) $\times$ 6, Removable terminal plug (10 pins) $\times$ 1, Cord clamp $\times$ 1, Mounting screw $\times$ 4 |
| <b>Option</b>                | AC adapter: AD-246  |

# AN-001T Ambient Noise Controller Module



The AN-001T is a plug-in module of 2-channel ambient noise detector designed for use with the M-9000. It automatically adjusts the output volume in response to the change of ambient noise level. The AN-001T can handle input signals from microphone level (-60dB) to line level (-10dB) by controlling the gain in 9 steps. Phantom power (+24V) can be supplied for condenser microphone use.

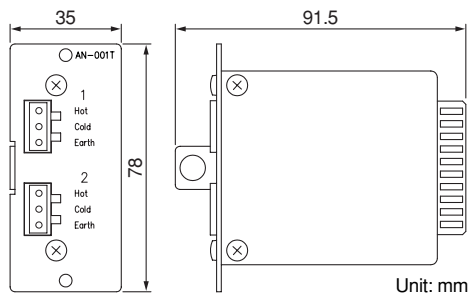

## SPECIFICATIONS

|                                       |   |
|---------------------------------------|---|
| <b>Power Requirement</b>              | +24 V DC, -24 V DC, +6 V DC   |
| <b>Current Consumption</b>            | 20 mA (at +24 V DC), 20 mA (at -24 V DC), 60 mA (at +6 V DC)  |
| <b>Input</b>                          | Sensor input (Ambient noise sensor microphone input):<br>2 channels, 3 k ohms (when the phantom power is ON)/10 k ohms (when the phantom power is OFF), electronically-balanced, removable terminal block (3 pins)  |
| <b>Input Sensitivity</b>              | -60, -54, -48, -42, -36, -30, -24, -18, -10 dB* (selectable)  |
| <b>Phantom Power</b>                  | +24 V DC  |
| <b>A/D Converter</b>                  | 24 bit $\Delta\Sigma$ ADC   |
| <b>Sampling Frequency</b>             | 48 kHz  |
| <b>Ambient Noise Control Function</b> | Sensor input reference level adjustment function<br>Maximum output signal level control: -15 to 0 dB<br>Minimum output signal level control: -18 to -3 dB<br>Sample time setting: 10 s, 15 s, 20 s, 30 s, 1 min, 2 min, 3 min, 5 min<br>Gain ratio setting (Ambient noise: Output signal level):<br>6:3, 5:3, 4:3, 3:3, 3:4, 3:5, 3:6, 6:3, 5:3, 4:3, 3:3, 3:4, 3:5, 3:6, |
| <b>Operating Temperature</b>          | -10°C to +40°C  |
| <b>Finish</b>                         | Panel: Aluminum, hair-line  |
| <b>Dimensions</b>                     | 35 (W) × 78 (H) × 91.5 (D) mm   |
| <b>Weight</b>                         | 82 g  |
| <b>Accessory</b>                      | Removable terminal plug (3 pins) × 2, Module mounting screw × 2   |
| <b>Option</b>                         | Ambient Noise Sensing Microphone: AN-9001   |

\*0 dB = 1 V

# AN-9001 Ambient Noise Sensing Microphone

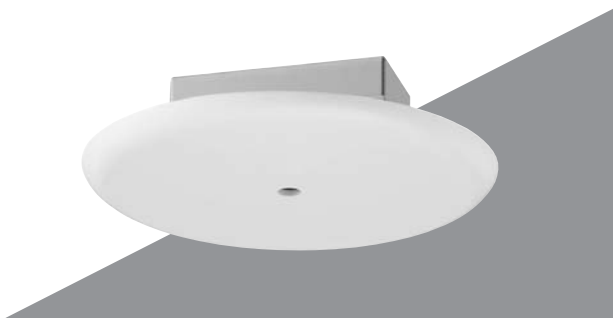

The AN-9001 is an electret condenser microphone designed for ambient noise detection. It is used in conjunction with the AN-001T Ambient Noise Controller Module. It can be mounted in an American standard 1-gang electrical box in the ceiling or wall.

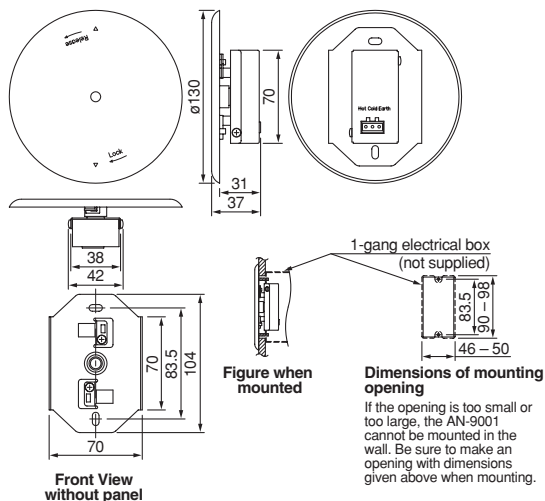

## SPECIFICATIONS

|                              |  |
|------------------------------|--|
| <b>Type</b>                  | Electret condenser microphone  |
| <b>Phantom Power</b>         | 14-26 V DC   |
| <b>Current Consumption</b>   | 7 mA (at 24 V DC)  |
| <b>Directivity</b>           | Omnidirectional (hemispherical)  |
| <b>Impedance</b>             | 200 ohms   |
| <b>Rated Sensitivity</b>     | -5 dB (1 kHz, 0 dB = 1 V/Pa)   |
| <b>Frequency Response</b>    | 100-10,000 Hz  |
| <b>Output Terminal</b>       | Removable terminal block (3 pins)  |
| <b>Operating Temperature</b> | -10°C to +40°C   |
| <b>Finish</b>                | Panel: ABS resin, white<br>Frame, Case: Surface-treated steel plate  |
| <b>Dimensions</b>            | $\phi 130 \times 37$ (D) mm  |
| <b>Weight</b>                | 170 g  |
| <b>Accessory</b>             | Removable terminal plug (3 pins) × 1,<br>Box mounting screw (No.6-32UNC x 30) × 2,<br>Box mounting screw (M4 x 30) × 2 |
| <b>Option</b>                | Ambient Noise Controller Module: AN-001T   |

Note: Since no electrical box is supplied with the unit, prepare it separately.

# ZP-001T Telephone Zone Paging Module

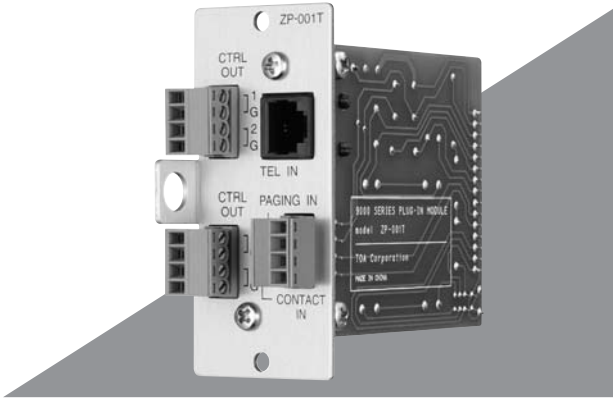

The ZP-001T is a zone paging module designed for use with the M-9000 and functions as interface to connect the M-9000 to an analog PABX, allowing zone paging to be initiated from the PABX. There are two operation modes: ring signal and paging port modes. Broadcast can be initiated regardless of operation mode.

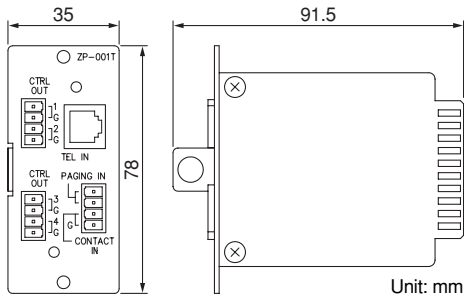

## SPECIFICATIONS

|                              |  |
|------------------------------|--|
| <b>Power Requirement</b>     | +24 V DC, +6 V DC  |
| <b>Current Consumption</b>   | 38 mA (at +24 V DC), 18 mA (at +6 V DC)  |
| <b>Number of Line</b>        | 1 line   |
| <b>Type of Selectable</b>    | Signal DTMF signal   |
| <b>Signaling System</b>      | Loop-Start (or Ground-Start, selectable)   |
| <b>TEL Line</b>              | 0 dB, 600 ohms, balanced, transformer-isolated, loop voltage: 24 V DC or more, which should be supplied from the PABX, RJ11 connector    |
| <b>Paging Input</b>          | 0 dB, 600 ohms, balanced, transformer-isolated audio input, removable terminal block (4 pins)  |
| <b>Control Input</b>         | 1 channel, no-voltage make contact, open voltage: 5 V DC, short-circuit current: 0.5 mA, removable terminal block (4 pins)               |
| <b>Control Output</b>        | 4 channels, open collector output (isolated), withstand voltage: 35 V DC, control current: max. 50 mA, removable terminal block (4 pins) |
| <b>Operating Temperature</b> | -10°C to +40°C   |
| <b>Finish</b>                | Panel: Aluminum, hair-line   |
| <b>Dimensions</b>            | 35 (W) × 78 (H) × 91.5 (D) mm  |
| <b>Weight</b>                | 153 g  |
| <b>Accessory</b>             | Removable terminal plug (4 pins) × 3, Module mounting screw × 2  |

# ZM-9001 Remote Panel



The ZM-9001 is a remote control switch panel used with the M-9000. It provides an additional 6 control inputs of amplifier expansion, and can be mounted in an American standard 1-gang electrical box in the wall. Up to 2 ZM-9001/9002 units can be connected to the M-9000.

## SPECIFICATIONS

|                              |   |
|------------------------------|---|
| <b>Applicable Cable</b>      | Single conductor shielded cable   |
| <b>Line Resistance</b>       | Under 50 ohms (per line)  |
| <b>Terminal</b>              | M3 screw terminal, distance between barriers: 7.62 mm   |
| <b>Operating Temperature</b> | -10°C to +40°C  |
| <b>Finish</b>                | Surface-treated steel plate, white, paint   |
| <b>Dimensions</b>            | 72 (W) × 127 (H) × 45 (D) mm  |
| <b>Weight</b>                | 170 g   |
| <b>Accessory</b>             | Box mounting screw (No.6-32UNC × 30) × 2,<br>Box mounting screw (M4 × 30) × 2, Panel mounting screw × 2 |

Note: Since no electrical box is supplied with the unit, prepare it separately.

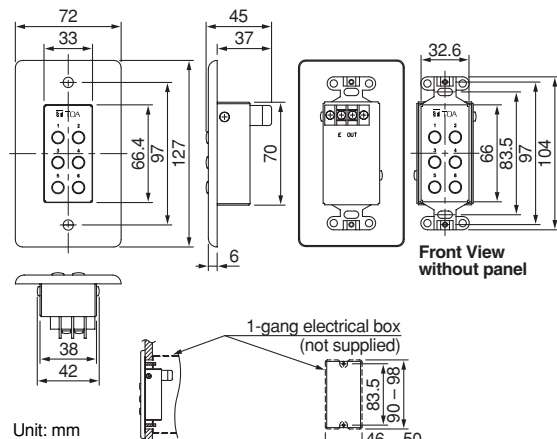

**Figure when mounted** **Dimensions of mounting opening**  
If the opening is too small or too large, the ZM-9001 cannot be mounted in the wall. Be sure to make an opening with dimensions given above when mounting.

# ZM-9002 Remote Panel



The ZM-9002 is a remote control switch/volume panel used with the M-9000.

It adds 4 amplifier control inputs and 1 remote volume control, and can be mounted in an American standard 1-gang electrical box in the wall. Up to 2 ZM-9001/9002 units can be connected to the M-9000.

## SPECIFICATIONS

|                              |   |
|------------------------------|---|
| <b>Applicable Cable</b>      | Single conductor shielded cable   |
| <b>Line Resistance</b>       | Under 50 ohms (per line)  |
| <b>Terminal</b>              | M3 screw terminal, distance between barriers: 7.62 mm   |
| <b>Operating Temperature</b> | -10°C to +40°C  |
| <b>Finish</b>                | Surface-treated steel plate, white, paint   |
| <b>Dimensions</b>            | 72 (W) × 127 (H) × 56 (D) mm  |
| <b>Weight</b>                | 170 g   |
| <b>Accessory</b>             | Box mounting screw (No.6-32UNC × 30) × 2,<br>Box mounting screw (M4 × 30) × 2, Panel mounting screw × 2 |

Note: Since no electrical box is supplied with the unit, prepare it separately.

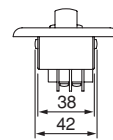
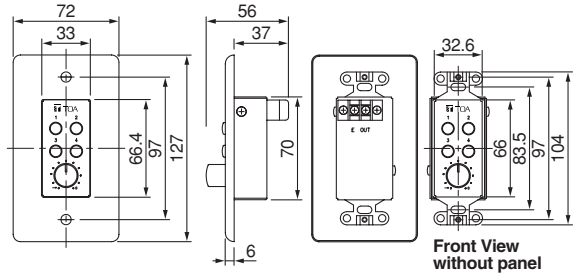
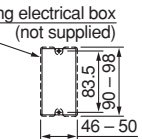

Figure when mounted

Unit: mm

Front View without panel



Dimensions of mounting opening

If the opening is too small or too large, the ZM-9002 cannot be mounted in the wall. Be sure to make an opening with dimensions given above when mounting.

# ZM-9003 Remote Panel

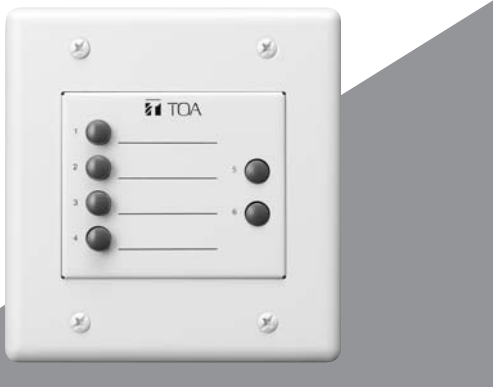

The ZM-9003 is a remote control switch panel with 4 interlocking selection switches and 2 momentary switches. Connecting it to the M-9000's control input terminal permits various controls such as BGM source selection and the sound volume adjustment. It can be mounted in an American standard 2-gang electrical box in the wall. Up to 2 ZM-9003 units can be connected to the M-9000.

## SPECIFICATIONS

|                              |  |
|------------------------------|--|
| <b>Line Resistance</b>       | Under 250 ohms (per line)  |
| <b>Terminal</b>              | Removable terminal block (7 pins)  |
| <b>Operating Temperature</b> | -10°C to +40°C   |
| <b>Finish</b>                | Surface-treated steel plate, white, paint  |
| <b>Dimensions</b>            | 120 (W) × 127 (H) × 53.3 (D) mm  |
| <b>Weight</b>                | 375 g  |
| <b>Accessory</b>             | Box mounting screw (No.6-32UNC × 30) × 4,<br>Box mounting screw (M4 × 30) × 4, Panel mounting screw × 2,<br>Removable terminal plug (7 pins) × 1 |

Note: If controls of more than 4 channels are needed, then additional C-001T Control Input/Output Module is required to expand control inputs.  
Since no electrical box is supplied with the unit, prepare it separately.

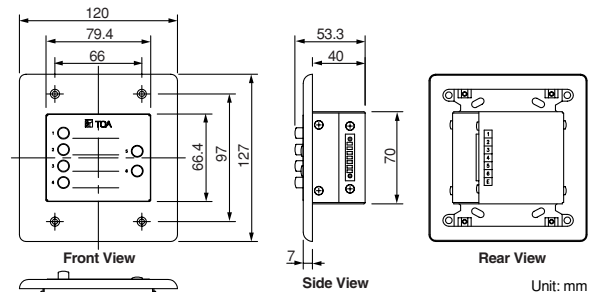

Front View

Side View

Rear View

Unit: mm

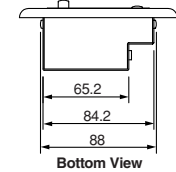

Bottom View

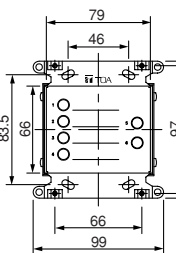

Dimensions of mounting opening

If the opening is too small or too large, the ZM-9003 cannot be mounted in the wall. Be sure to make an opening with dimensions given above when mounting.

Figure when mounted

Ground the electrical box to avoid unit malfunction due to static electricity.

Front View without panel

# BLOCK DIAGRAM

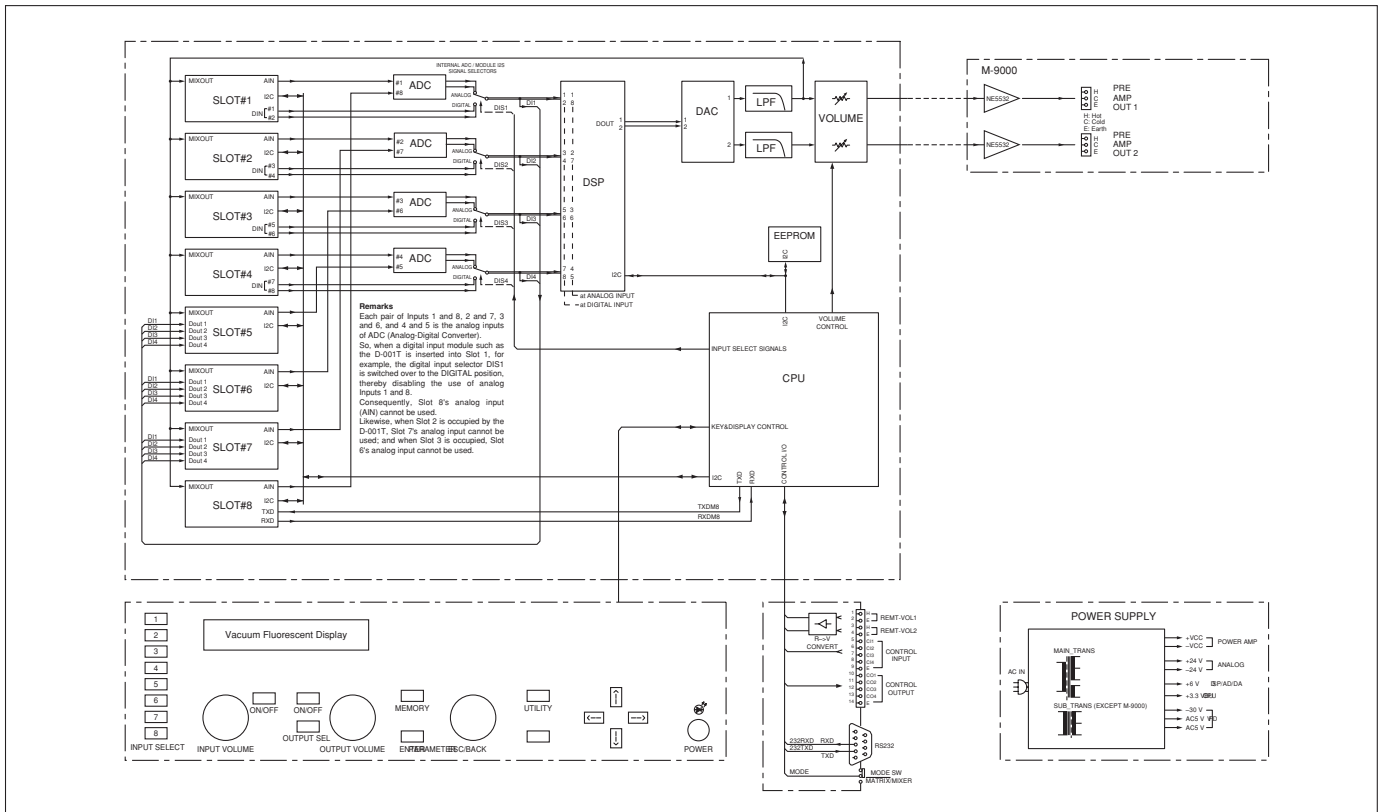

# ARCHITECTURAL AND ENGINEERING SPECIFICATIONS

The digital matrix mixer shall use digital signal processing for all mixing and signal processing functions and shall be modular for flexibility in system configuration. The mixer shall have a frequency response from 20 Hz to 20 kHz, 3 dB.

The digital matrix mixer shall utilize a modular architecture and be capable of up to eight input channels and eight output channels. Eight module ports shall be provided. Module ports shall include four digital input ports and three digital output ports. Each digital input port shall accept two input channels and each digital output port shall provide up to two output channels. All eight module ports shall accept analog input modules and shall support control I/O function modules and analog output modules. The mixer shall have eight independent mixing busses. Balanced line output connections for mix busses 1 and 2 shall be provided on the rear panel.

All software-based settings shall be accessible from the front panel controls. Thirty-two FLASH memory presets shall be available to store event or scene data. Programming of the mixer input/output routing and digital processor settings shall be event-based. Each input channel shall support event-based [or scene-based] programming of the following settings: channel priority, ducking on/off status, ducking depth, input to output routing, and remote contact activation. Up to 8 priority levels shall be available. Inputs assigned to the same priority level shall operate according to one of three selectable logic rules: First in, first out (FIFO); Last in, first out (LIFO); or mixing.

Input channels equipped with a dedicated input module shall support event-based [or scene-based] programming of the following settings: channel priority, ducking on/off status, ducking depth, input to output routing, remote contact activation, VOX trigger threshold, high and low pass filters, 10-band parametric equalization, compression, bass and treble, and loudness compensation. Each built-in output channel and each output channel equipped with a dedicated in/out module shall support event-based [or scene-based] programming of the following settings: high and low pass filters, 10-band parametric equalization, compression, bass and treble, loudness compensation, and pre-programmed speaker equalization settings.

A power off mode setting shall allow selection of whether input and output volume settings revert to pre-programmed default levels or retain the last used setting after

the power is turned off and back on. A power on mode setting shall allow selection of whether to revert to the last used preset event at power on, and if not, which preset event is to be active at power on.

Security features shall include a key-lock setting to selectively disable user changes to input, output, and/or utility settings. Input and output channels shall be selectable for user lock-out on an individual channel-by-channel basis. Password protection of the lock-out settings shall be available by the use of a user-selected password. The digital matrix mixer shall have a built-in RS-232 port for connection to a Windows-based computer for storage and retrieval of setup information and for connection to third-party ASCII-based serial control systems. Software to enable PC-based data storage and retrieval shall be provided free of charge. Stored information shall include all software-based settings. The RS-232 port and software shall also provide for future FLASH upgrades of the software-based feature set.

Four control contact inputs shall allow event activation by remote dry contact closure. The function of each control input shall be software assignable activate Event, Volume Up/Down (Input or Output), Mute (Input or Output), Power On/Off, Emergency Mute or Synch On/Off Control inputs shall be expandable to twelve with a dedicated in/out control module.

Four open-collector control outputs shall allow triggering of external equipment based on event status. The function of each control output shall be software assignable using front panel controls.

Each of two remote volume control channels shall be assignable to allow the volume of any one input or output channel to be remotely controlled using a 10k ohm linear taper potentiometer or a DC control voltage varying over the range of 0 to 10 volts.

Each built-in output channel shall be transformer isolated and shall meet or exceed the following specifications: Output impedance: 600 ohms, balanced; output level: 0 dBV nominal, where 0 dBV = 1 volt; frequency response: 20 Hz to 20 kHz (+1, -3 dB); output distortion: 0.008%, measured at 1 kHz at dBV output (where 0 dBV = 1 volt) with 22 kHz low pass filter; output connector: 4-pin removable terminal block.

Dimensions shall be 482.6(W) x 132.6(H) x 320(D) mm and weight shall be 6 kg.